

FACE FIX KEY SAFE

OPERATING AND FITTING INSTRUCTIONS

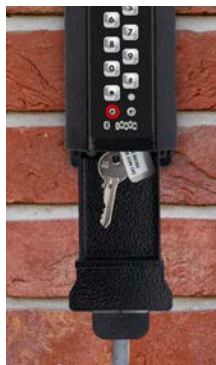

Secured by Design



Official Police Security Initiative



INSTALLATION GUIDE

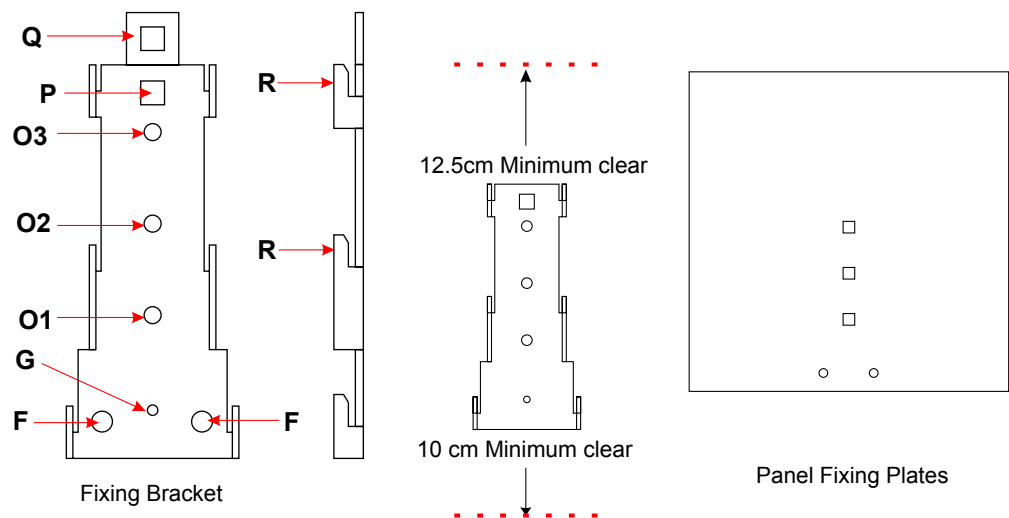
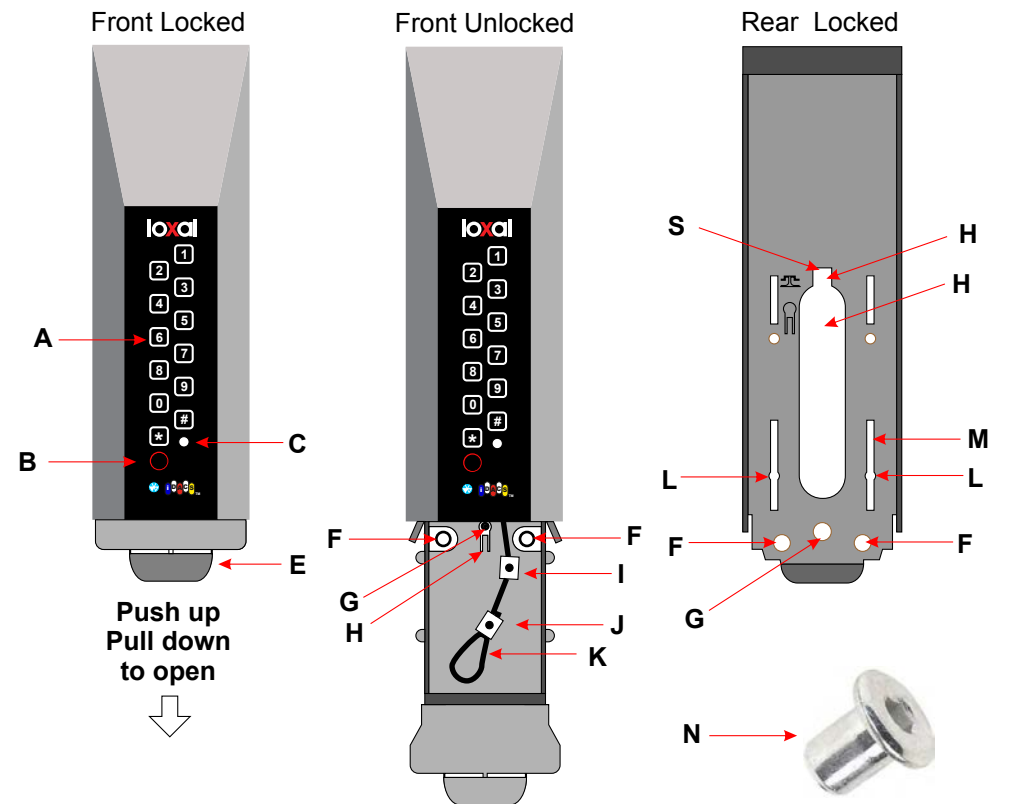

USER GUIDE

Enter a valid 7 digit code on the keypad 'A'

You will hear a beep with each button push and the LED 'C' will flash

An alternative short double beep will confirm an accepted code and the LED will stay illuminated

Push up then pull drawer 'E' down within 5 seconds while LED is illuminated

Pull out key attached to retractor 'K' if fitted or remove from key hook

Carefully replace key ensuring free movement of the drawer

Push up drawer to relock

PLEASE ENSURE THAT KEYS ARE ALWAYS SAFELY RETURNED

Setting and unsetting Alarm with Key Safe Alarm Interface (where fitted)

Entering a valid code will automatically unset the alarm

To reset alarm enter *# 00 your code

The drawer does not need to be used to operate this function

PROBLEM SOLVER

Code entered is followed by a negative double beep, safe does not unlock

Your code is not valid, it may be out of permitted hours of use, expired or barred

Check validity with operator

Download the free Loxal app. Press Scan, then press any button on the key safe keypad

Press the unit number highlighted on the app. The unit will automatically update

There is no beep or LED light when button is pressed

Unit is locked out after 20 incorrect attempts. wait for 3 minutes and retry or battery is dead

Solution:

Hold a PP3 battery against the emergency power up terminals 'B' with positive + terminal against the red contact screw

Continue to hold battery against terminal throughout the process

When buttons are live continue to hold battery, enter code and pull down drawer, report fault to the operator

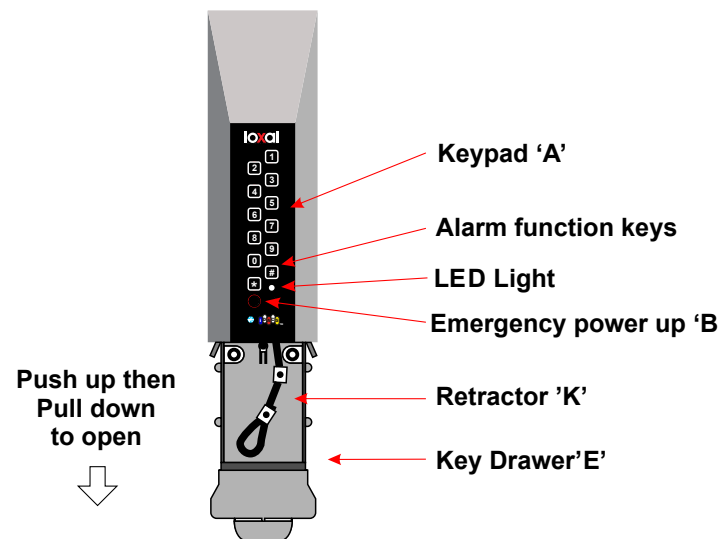

LOXAL FACE FIX KEYSAFE INSTALLATION GUIDE

To install you must possess a valid code and preferably have downloaded the free Loxal Audit app on your device and receive an activation code from your administrator. Before installing, if you have the Loxal app, open, press scan. press any button on the key safe, the app should show the unit number of the safe. press on unit number displayed. this will update the unit and transmit the audit trail. Enter your 7 digit code on the safe, push up and pull down the key drawer to open.

Select the site for the key safe.

If you are utilising the retractable lanyard then the unit must be no further than 1.4 mts from the furthest lock.

Choose the fixing method

A - Fixing to a flat surface with no access to the rear. *Below*

B - Fixing to a Door or panel with rear access to the fixings. Page 5

C - Fixing to a gate, fence or panel where secure fixing is required from both sides. Page 6

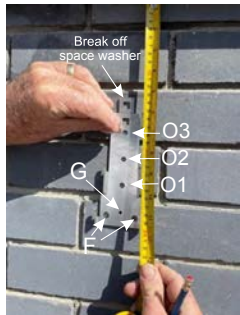

Fig 1.



Fig 2.



Fig 3.

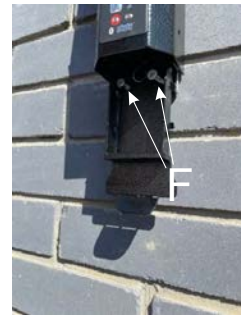

Fig 4.

A - Fixing to a flat surface with no access to the rear

4 point fixing (preferred), mark holes O3 & O2 and F x 2 (drill and plastic plug if necessary). Secure bracket to surface through holes O3 and O2 with size 5 screws, 6mm expanding wall bolts, M6 coach screws or pop rivets. (Fig 2.)

(At this stage **DO NOT** insert screws into holes 'F')

With the safe in the open position, locate slots in the rear onto the bracket and push down. Now secure screws through access holes in open drawer in holes 'F' (Fig 4.)

Alternative 2 point fixing

Fit bracket to flat surface through holes 'O1' and 'O3' with 5 mm screws, 6mm expanding wall bolts. M6 coach screws or pop rivets With safe in the open position locate bracket lugs 'R' into rear of safe 'M' and push down. Tighten grub screw 'G' into locating hole in bracket. Push up drawer to lock

Attach keys to retractor 'K' by loosening off grub screw in ferrel 'J' and insert keys through loop.

Ferrel 'I' may be loosened and repositioned to offer the keys in the correct position.

DO NOT LOOSEN FERRELS 'I' AND 'J' AT THE SAME TIME

Alternatively lever down key hook 'H' with a screwdriver.

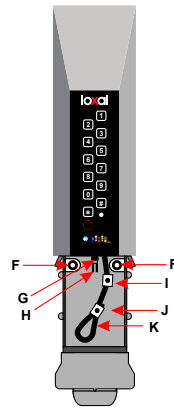

B - Fixing to a door or panel with rear access

The safe may be bolted through a door or panel through a 10-14 mm hole. You may utilise an existing hole by removing a door spyhole, knob or knocker or insert a new 10mm hole.

The safe may be fitted with the provided bracket or just the break off spacer washer 'Q'.

You will require an M8 coach bolt of the correct length.(not provided) If you are securing with a nut and washer on the inner face the bolt should be a minimum of 12mm greater than the material you are fixing through.

If you are fixing with a female sleeve nut 'N' then the bolt should be 3-7 mm less than the material you are fixing through.

Push the M8 bolt through the bracket or spacer washer. Insert into square slot in rear of safe 'S' Push bolt through hole in panel and secure from rear side with nut and washer or female sleeve nut 'N'. With the unit open, a screw may be fitted through one of the holes 'F' to prevent the unit swivelling.

Attach keys to retractor 'K' by loosening off grub screw in ferrel 'J' and insert keys through loop.

Ferrel 'I' may be loosened and repositioned to offer the keys in the correct position.

DO NOT LOOSEN FERRELS 'I' AND 'J' AT THE SAME TIME

Alternatively lever down key hook 'H' with a screwdriver.

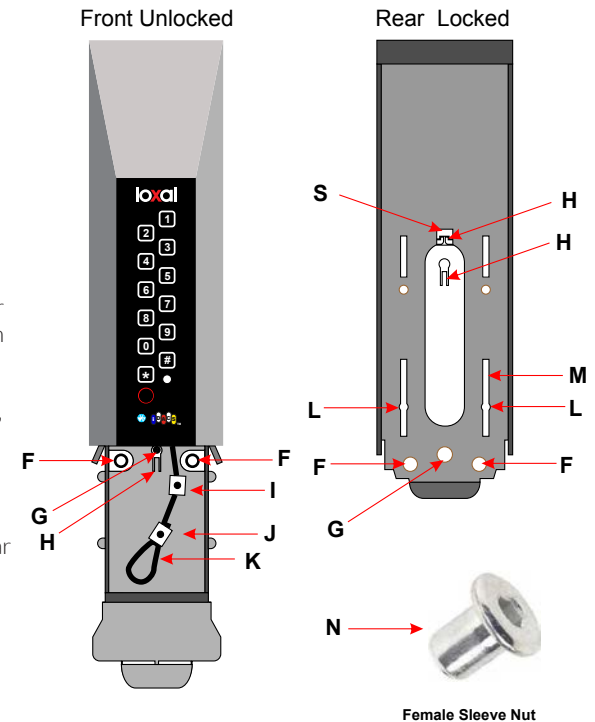

Female Sleeve Nut



C - Fixing to a gate fence or panel where secure fixing is required from both sides

Fixing to a solid panel. Drill two 6mm holes to line up with bracket fixing holes O1 and O3

Bolt bracket onto panel with coach bolt heads on secure side bolt bracket to panel with securing nuts against the bracket. cut bolts to length so they do not protrude more than 9mm

With the safe open locate slots on rear of safe 'M' onto bracket lugs 'R' and push down. screw in grub screw 'G' through open drawer access hole

Fixing to a mesh panel /fence/pailing/gate

Push two 6mm coach bolts through a Loxal Panel Fixing Plate (not provided) and sandwich fence/

gate between the two panel fixing plates, secure bracket with nuts on the bracket side

Cut bolts to length so they do not protrude more than 9mm

With the safe open, locate slots on rear of safe 'M' onto bracket lugs 'R' and push down. screw in grub screw 'G'

Attach keys to retractor 'K' by loosening off grub screw in ferrel 'J' and insert keys through loop. Alternatively lever down

key hook 'H' with a screwdriver

VIDEOFIED INTEGRATION

- 1 - On your Videofied keypad go to "Add a New Device" and Press "OK"
- 2 - On the IDACS keypad enter *#36, this will begin the pairing process. Once paired the Videofied keypad will confirm 'Fob', press OK. Now go to 'Add Another Device' and press OK.
- 3 - On the IDACS keypad enter *#37, this will begin the pairing process. Once paired the Videofied keypad will confirm 'Detector', press OK. You can now test RF level.

The unit is now paired.

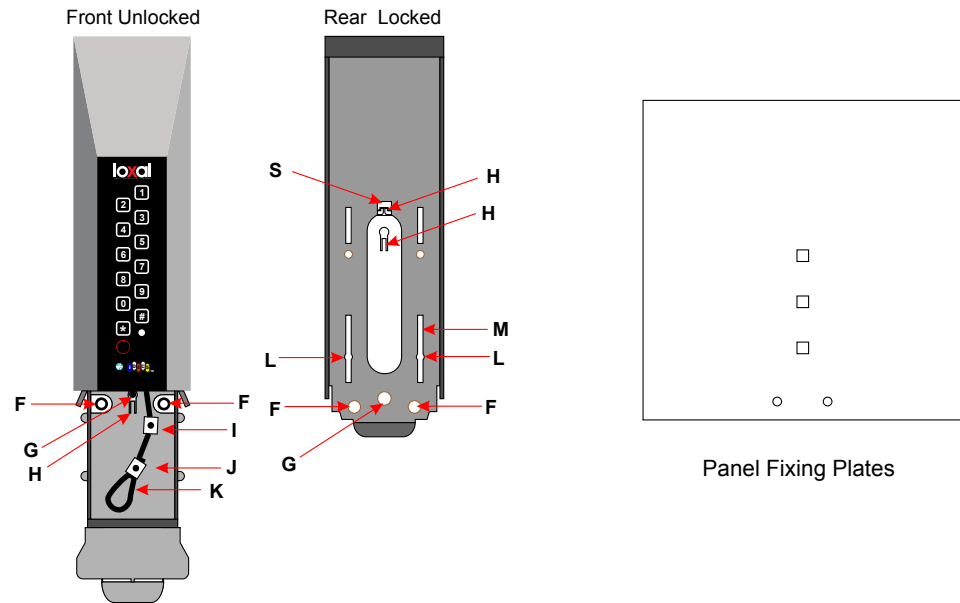

Also available from Loxal

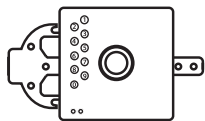

Block Lock

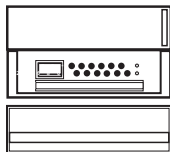

Letterbox Key Safe



Integrated visual
verification wireless
alarm system

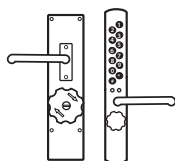

Digital Lock
Converter

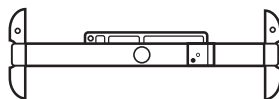

Locking Bar

FOR TECHNICAL SUPPORT CALL 0800 917 2994

Loxal Security Unit 5, Sevenoaks Business Centre,
Cramptons Road, Sevenoaks TN14 5DQ
info@loxalsecurity.com | loxalsecurity.com